

FAG

6010-H-2Z

Deep groove ball bearing

Schaeffler ID:
0938834710000

Deep groove ball bearing 60..-H-2Z, single row, H-Series, shields, steel sheet metal cage

Technical information

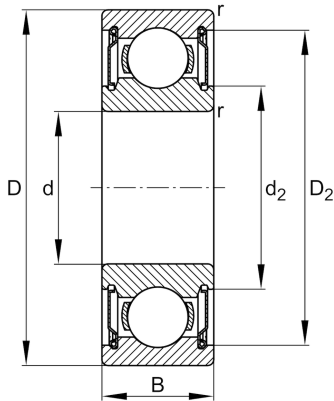
**Main Dimensions & Performance Data**

d	50 mm	Bore diameter
D	80 mm	Outside diameter
B	16 mm	Width
C_r	20.770 N	Basic dynamic load rating, radial
C_{0r}	15.600 N	Basic static load rating, radial
C_{ur}	920 N	Fatigue load limit, radial
n_G	10.300 1/min	Limiting speed
n_{gr}	8.900 1/min	Reference speed
	0,254 kg	Weight

Dimensions

r_{min}	1 mm	Minimum chamfer dimension
D_2	73,1 mm	Caliber diameter outer ring
d_2	56,7 mm	Caliber diameter inner ring

Mounting dimensions

d_{amin}	54,6 mm	Minimum diameter shaft shoulder
D_{amax}	75,4 mm	Maximum diameter of housing shoulder
r_{amax}	1 mm	Maximum fillet radius

Calculation factors

f_0	15,7	Calculation factor
-------	------	--------------------

Temperature range

T_{min}	-20 °C	Operating temperature min.
T_{max}	120 °C	Operating temperature max.

